

# Operating manual for **Industrial valves**



## Table of content

Introduction.....	3
Safety instructions .....	3
Warnings.....	3
General safety advices .....	3
Intended use .....	4
Safe and correct use, advices for the plant operator .....	4
Special hazards .....	4
Labelling of the valve .....	5
Transport and storage .....	5
Installation to the piping system .....	5
General.....	5
Preparation of the valves for usage.....	5
Installation with intermediate flange housing.....	6
Installation with flange housing.....	6
Installation requirements for shut-off valves .....	7
Installation steps for shut-off valves .....	7
Pressure test.....	9
Maintenance.....	9
Service .....	9
Actuator and Accessories .....	9

# 1. Introduction

This operating instruction is used to support the installation, the operation and the maintenance of ARIS valves. To guarantee the correct and safety operation of our valves, this operating instruction must be read and understood before installation. Particularly the safety instructions are to be followed.





This manual serves as basis to install and operate ARIS valves safety conform. All persons working with or on ARIS actuators must observe this manual and especially its safety advices.

## 2. Safety instructions

### 2.1 Warnings

Symbols: Installation and initial operation only by certified experts according to the manual.

Observe the significance of the following symbol and note explanations. They are subdivided in security levels and classified according to ISO 3864-2.

	DANGER indicates a hazard with a high risk degree, which, if not avoided, causes death or heavy injuries.
	WARNING indicates a hazard with a medium risk degree, which, if not avoided, can cause death or heavy injuries.
	CAUTION indicates a hazard with a low risk degree, which, if not avoided, can cause slight or moderate injuries.
	Indicates general advices, useful hints and work recommendations, which don't have influence on the safety and health of the staff.

### 2.2 General safety advices

The valves are conform to the state of the art and apply as generally safe at the time they are shipped.

	<ul style="list-style-type: none"><li>• This manual has to be kept at the operating place at any time.</li><li>• Read the manual carefully prior to installation and initial operation.</li><li>• Ignoring the following danger and warning notes may result in hazards and loss of manufacturer's warranty.</li></ul>
--	--

- Working on industrial valves is only allowed for qualified persons.
- Observe all safety and accident prevention regulations while installing, operating and testing any machinery.
- Prior to all installation or regular work on the actuator make sure to switch off all connected machinery/appliances.

	Disregarding this manual or incorrect use of the valves may lead to the loss of the warranty.
--	---

### 3. Intended use

The valves are designed to throttle, to control, or to shut-off a medium flow within the allowed pressure and temperature limits after mounting as their only task. Please take the allowed range of pressure and temperature out of the planning documents.

Only clean, liquid or gaseous media against which the materials used are resistant, can be used as well as powdered, viscous media and bulk materials, provided they are suitable for valves.

#### 3.1 Safe and correct use, advices for the plant operator

The same safety regulation that applies for the tubing-systems applies for our valves too. This instruction gives only such safety guidelines that additionally are to consider.

It does not lie in the responsibility of the manufacturer and, therefore, it is to be guaranteed with the use of the valves, that

- the valves be used as described in section 2 (intended use);
  - the tubing system is professional shifted, and been inspected regularly. The lay out of the wall thickness of the valve is designed to consider the traction power and traction torques with usually predominate in a professional shifted tube-system;
  - the valve is professionally attached to the system;
  - in this system the usual flow velocities in continuous operation not to be exceeded, and abnormal operating conditions such as water hammers, cavitations, vibrations and also slight solids in the medium (particular high wear) are clarified with ARIS valves;
  - valves that are working in operating temperatures  $>50^{\circ}\text{C}$  or  $<-20^{\circ}\text{C}$  must be protected against contact with the pipe connections;
  - for pressurized tubes only competent stuff will operate und service the valves.
- 
- Make sure that the initial operation or the test adjustment no potential hazards arise for personnel or the environment.
  - If necessary, set up warning signs to prevent the inadvertent starting up or shutting down of the devices/machines/plant.
  - Check the correct function after setting up and, where appropriate, the required angular position of the valves.
  - Check the correct function of the limit switches (option).
  - Make sure that the valve ist shut 100% when the control unit signalizes the appropriate end position (option).
  - Avoid the pinching of limbs by moving valves with necessary safety measures.
  - Check the correct function of possible safety elements (e.g. Emergency Stop/Safety valves etc.)!
  - Run the starting and the adjustments only in accordance with the procedures described in this document!

#### 3.2 Special hazards



Before dismantling the valve from the tube, or before loosening the screws of the bearing cover or the stuffing-box (packing), the pressure of the tube must be stooped completely, so that the medium can not escape uncontrolled out of the tube.



**DANGER**

If the valve must be removed from the tube, it is possible that the medium can escape out of the tube or the valve. If the medium is harmful or dangerous, the tube must be completely drained before the valve will be removed. Be careful with residues that can follow out of the tube or residues that remains in dead storages.

### 3.3 Labelling of the valve

Only the valves that we have explicit quoted and build according to PED (pressure equipment directive) will be labelled via type plant with the following details:

Valve Type	
Housing material	1.4301
Size	DN (and value)
max. pressure	PN (value)
allowed temperature	tb (and value)
Manufacturing no./year	XXX/20..
Conformity	CE

Markings on the body and on the nameplate must be maintained so that the valve remains identifiable.



**ADVICE**

Valves acc. to PED are equipped with the original operating manual by the manufacturer.

## 4. Transport and storage

Valves must be handled, stored and transported accurately, and carefully:

- The valve is to be transported and stored in its own protective packaging till installation.
- In case of storage before installation the valve should be stored as a rule in a closed room and be protected against injurious influence like dirt or humidity.
- In particular the flange seal face may be damaged neither by mechanical nor by other influence. Unpacked armatures do not stack!
- As a rule valves are delivered in closed position. They must be stored in such a way as they were delivered. The valve may not be operated before installation.

## 5. Installation to the piping system

### 5.1 General

For the installation of the valves in a pipe the same instructions counts like for the connection of pipes and similar conduit elements. The following instructions count to valves, in addition. For the transport to the installation place is also to be followed section 4.

#### 5.1.1 Preparation of the valves for usage

- Make sure that only valves are inserted whose pressure class, connection kind and connection dimensions correspond to the application terms.
- Check valves and accessories for transport damages. Damaged valves may not be installed.

- The counter flanges of the conduit must be aligned and coplanar.
- Before installation the valve and the conduit must be cleaned from soiling.
- The direction of the flow is to be clarified with the manufacturer and must be given in the order by the customer.

**! ADVICE**

The given installation position for the armatures from DN 250 is with horizontal shaft. Other installation positions are to be clarified with the manufacturer.

- With the installation in a conduit the distance to the conduit ends must be calculated in this way that the seals and the sealing surfaces of the counter flanges can not become damaged. But the distance should not be bigger than necessary so that no tensions can be generated in the tube while tighten the tubes-connections.
- While installation the valve is to be centered very carefully.

### 5.2 Installation with intermediate flange housing

- Bring the valve to not fully closed position so that the disc does not protrude from the housing.
- Slide the valve between the flanges. The flap must be pushed between the flanges slightly.
- Align the valve with the flange and slide suitable screws through the flange holes.
- Screw respective nuts on the screws and tighten them evenly crosswise to easily.
- Check that the disc will open and close easily. Leave the disc slightly open then.
- Tighten all flange bolts crosswise and check the operation of the valve.

**! ADVICE**

Check the maximum tightening torque of your chosen bolting.

- Check all connection for leakage.

For installation of valve types RD-K, L6-FD, L5-RD, HT-L, HT-2B and BALK use appropriate flange sealings in respect of media and operation conditions.

Do not use flange sealings at valve types BARI and BAMF, since the sealing overhang is the flange sealing at once.

### 5.3 Installation with flange housing

- Bring the valve to not fully closed position so that the disc does not protrude from the housing.
- Align the valve with the flange and slide suitable screws through the flange holes.
- Check that the disc will open and close easily. Leave the disc slightly open then.
- Tighten all flange bolts crosswise and check the operation of the valve.

**! ADVICE**

Check the maximum tightening torque of your chosen bolting.

- Check all connection for leakage.
- Install any adequate protection to prevent from grasping or insertion of objects into the fitting.
- Install any suitable features to prevent uncontrolled escape of media.



## ADVICE

The unilateral flanging, the maximum permissible medium pressure decreases.

### 5.4 Installation requirements for shut-off valves

Soft-sealing shut-off valves are installed between piping flanges according to EN 1092-1 (formerly DIN2501) or ANSI B16.5.

The pipe must not have any axial or angular misalignment, otherwise the inner flap may be damaged. The seal of the butterfly valve is provided with a collar and thus „self-sealing“ to the flange surfaces and does not require additional flange gaskets.

Essential: The flange sealing surfaces are checked for error-free, smooth surface structure.

Residues (welding beads) must be removed. No cross marks may be visible yet. The inside diameter of the mating flanges - including inner coating - must be sufficient to allow the inner disc can open fully without touching. This must be verified prior to installation of the valve and compare with the dimensions of the flap.

### 5.5 Installation steps for shut-off valves

- With soft-sealing valves, the inside disc must be switched to a slightly angled position.
- The inner disc must not protrude beyond the original length of the flap.
- Gently slide the flap between sufficiently spread mating flanges.
- Center the butterfly valve with the flange screws. The housing outer diameter of the flap is used for full centering!



## ADVICE

- For on-site welding of pipe, fittings instead of the butterfly valve should be temporarily installed as sparks and welding residues can damage the seal by high temperatures.
- Never leave the valve installed to finish welding the pipe/flange.



## CAUTION

If the valve is used improperly installed between flanges, the gasket can move and be destroyed.

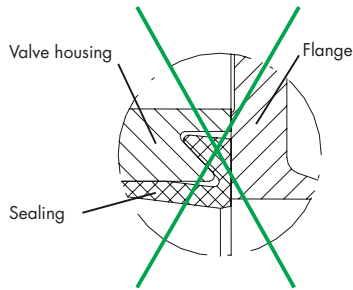

In this case, release the spreading of the pipe and tighten the flange screws crosswise smoothly and easily with fully opened inner disc. Check here the central position of the valve between the mating flanges.

Actuate valve several times and tighten the flange screws again crosswise in closed position.

**! ADVICE**

Check the maximum tightening torque of your chosen bolting.

It is necessary to check that the inner disc can be switched freely over the full swing angle.

**! ADVICE**

When installing the butterfly valve with lug as end protect the free port additionally with a blind flange.

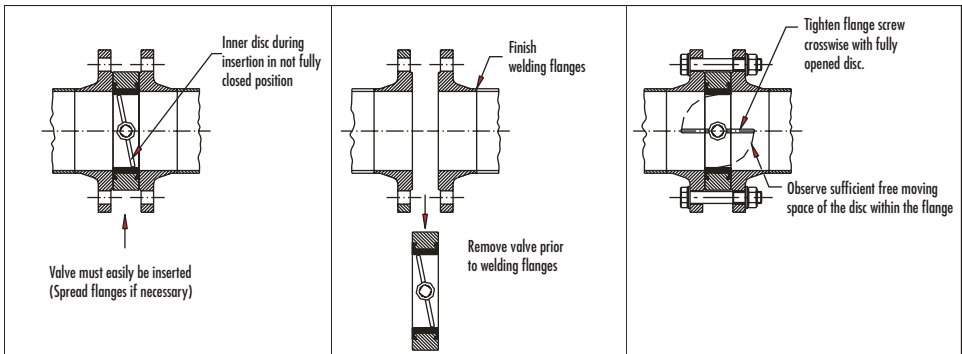

**! ADVICE**

- The mating flanges must have smooth sealing surfaces, e.g. forming B1 or B2 according to DIN EN 1092-1 (formerly DIN 2501) or Smooth Finish ANSI B 16.5. Other flanges shall be agreed with the manufacturer.
- The actuator is adjusted for the operation specified in the order: The setting of the „OPEN“ and „CLOSE“ should not be changed without the consent of the manufacturer.
- If a drive unit is retrofitted, torque, direction of rotation, operating angle and the setting of the „OPEN“ and „CLOSE“ must be adjusted. Failure to observe these precautions could mean danger for the user and cause damage to the pipeline system.



## 6. Pressure test

Butterfly valves are tested with air or water leaks prior to delivery. Remnants of the test medium at the contact surfaces of the valve may be present. A possible reaction with the operating medium must be observed.

In the pressure test of the tube with installed valve is to be followed:

- First off all new tubes have to be rinsed very close to remove containment in the system.
- Open Disk: The test pressure may not cross the value  $1.5 \times (PN \text{ or } PS)$ . (PS = maximum operating pressure).
- Closed Disk: The test pressure may not cross the value  $1.1 \times (PN \text{ or } PS)$ .

### **ADVICE**

Before the first operation, the pipeline must be flushed effectively with fully opened valve to eliminate impurities and to avoid damage to the sealing surfaces. The fitting must not be switched during the flushing process.

## 7. Maintenance

### 7.1 Service

### **ADVICE**

For hand operated valves it is not allowed to use all kind of extensions. The normal hand forces are sufficient.

### **ADVICE**

Hand Lever: The position of the lever shows the position of the disk of the valve.  
Lever  $90^\circ$  cross to the tube: Valve "CLOSED"  
Lever parallel to the tube : Valve "OPEN"

### **DANGER**

The opening and closing of the valve must occur in such a way that pressure pushes and/or temperature shocks are avoided. With nonobservance of this approach it can come to dangers for persons and the tubing system.

Regular servicing is not necessary to the valves. The leak tightness outwards via packing should be checked while servicing the whole installation. Ready installed valves should be moved OPEN/CLOSED from 4 to 5 times per year.

### **CAUTION**

The service may be carried out only by qualified trained staff which is authorized moreover.

### 7.2 Actuator and Accessories

For valves with actuator, to verify the disc position, the position indicators are on the drive. In structures with hand lever, it shows that position of the disc at once.

### **ADVICE**

- The regulations of the actuator and accessories manufacturer count to the installation, introduction and servicing
- Actuator and accessories are to be connected according to the separately presented circuit diagram. Observe the original operating manual of the manufacturer.
- During the mounting of the actuators the valves as well as the actuators have to be in the "OPEN" position.

## Notizen



*Subject to technical changes.*

**ARIS Stellantriebe GmbH**  
**Rotter Viehtrift 9**  
**53842 Troisdorf / Germany**

**[www.stellantriebe.de](http://www.stellantriebe.de)**

**Tel.: +49 2241 25186-0**  
**Fax: +49 2241 25186-99**  
**[aris@stellantriebe.de](mailto:aris@stellantriebe.de)**

